



# ADAPTORS

## ADAPTORS BETWEEN SERIES

HUBER+SUHNER is manufacturing a wide range of adaptors between series. Please find hereafter a selection of them.

If the requested type is not mentioned, please do not hesitate to contact the Sales Department of our Subsidiary or Agent in your country.



# ADAPTORS "BETWEEN SERIES"

		BMA		BNC		MCX		MMBX		MMCX		N		PC3.5	
		plug	jack	plug	jack	plug	jack	plug	jack	plug	jack	plug	jack	plug	jack
BMA	plug														
	jack														
BNC	plug					16	17/18			10/14	11/12	24/25	26/27		
	jack					19/20	15/21			13	9	28/29	22/23 30		
MCX	plug			16	19/20							65	66		
	jack			17/18	15/21							67/68	63/64/69		
MMBX	plug														
	jack														
MMCX	plug			10/14	13										
	jack			11/12	9										
N	plug			24/25	28/29	65	67/68								
	jack			26/27	22/23 30	66	63/64 69								
PC3.5	plug														
	jack														
QLA	plug				32										
	jack			31	33							75			
QMA	plug														
	jack														
QN	plug											77	106		107
	jack												76		
SMA	plug	2/6	4	35	37	71	73	55	57	60	62	79	81/84		
	jack	3/7	1/5/8	36	34/38	72	70	56	54	61	59	80	78/82/83		
SMB	plug			40	42							86	88		
	jack			41	39/43							87	85/89/90		
SMC	plug			45	47							92	94		
	jack			46	44							93	91/95		
TNC	plug			49	51/52							97	99/100		
	jack			50	48/53		74		58			98	96		
7/16	plug											102	104		
	jack											103	101/105		

## FINDING THE RIGHT ADAPTOR

In the tables on this spread you find the most frequently used HUBER+SUHNER adaptors.

### Note:

The VSWR values stated for the "Between Series" Adaptors on the next pages are typical values!

### Example:

Adaptor BNC plug - N jack

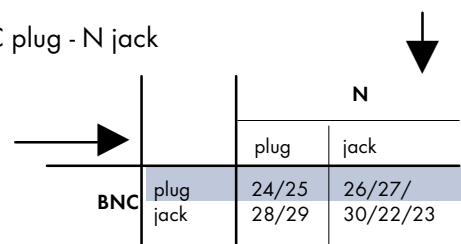

		QLA		QMA		QN		SMA		SMB		SMC		TNC		7/16	
		plug	jack	plug	jack	plug	jack	plug	jack	plug	jack	plug	jack	plug	jack	plug	jack
BMA	plug							2/6	3/7								
	jack							4	1/5/8								
BNC	plug		31					35	36	40	41	45	46	49	50		
	jack	32	33					37	34/38	42	39/43	47	44	51/52	48/53		
MCX	plug							71	72								
	jack							73	70						74		
MMBX	plug							55	56								
	jack							57	54						58		
MMCX	plug							60	61								
	jack							62	59								
N	plug		75			77		79	80	86	87	92	93	97	98	102	103
	jack					106	76	81/84	78/82 83	88	85/89 90	94	91/95	99 100	96	104	101 105
PC3.5	plug																
	jack					107											
QLA	plug																
	jack																
QMA	plug								108/109								
	jack							110									
QN	plug																
	jack																
SMA	plug										112			115	116		
	jack									113	111			117	114		
SMB	plug								113						118		
	jack							112	111								
SMC	plug																
	jack																
TNC	plug								117/119								
	jack							116		118							
7/16	plug																
	jack																

Number 26 indicates where to look for the required type. On the following pages you will find the sketches and descriptions of all types in numeric order. If you go to number 26 you find the following information:

**26**

H+S type  
Item No.

**33\_BNC-N-50-1/133\_NE**  
**22540608**

**BNC**  
**N**

**plug (m)**  
**jack (f)**

**Packaging**

single

Material:  
BNC  
N

brass/SUCO\*  
brass/SUCO\*

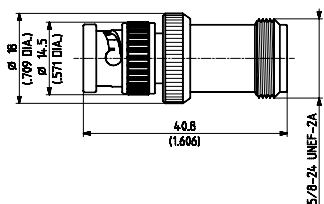

Material and plating descriptions may refer to the connector housing or outer contact.

SUCO\* = SUCOPLATE®  
SUPR\*\* = SUCOPRO

**1** H+S type Item no. 31\_BMA-SMA-50-1/1-9\_UE 22645642

BMA jack (f)  
SMA jack (f)

Packaging single

Material BMA stainless steel  
SMA stainless steel

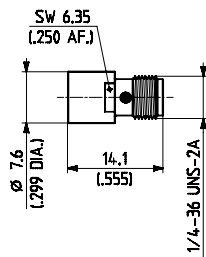

VSWR: DC - 9 GHz:  $\leq 1.04 + 0.02f$

**5** H+S type Item no. 34\_BMA-SMA-50-2/1\_UE 22645650

BMA jack (f)  
SMA jack (f)

Packaging single

Material BMA stainless steel  
SMA stainless steel  
Mounting hole ML 56

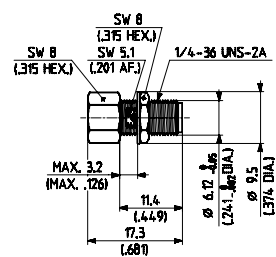

VSWR: DC - 18 GHz:  $\leq 1.05 + 0.005f$

**2** H+S type Item no. 32\_BMA-SMA-50-1/199\_UE 22645643

BMA plug (m)  
SMA plug (m)

Packaging single

Material BMA stainless steel  
SMA stainless steel

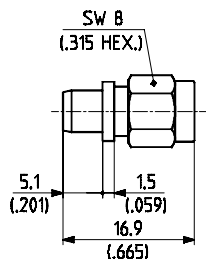

VSWR: DC - 9 GHz:  $\leq 1.067 + 0.017f$   
9 - 18 GHz:  $\leq 1.22$

**6** H+S type Item no. 35\_BMA-SMA-50-1/193\_UE 22645647

BMA plug (m)  
SMA plug (m)

Packaging single

Material BMA stainless steel  
SMA stainless steel  
Mounting hole ML 56

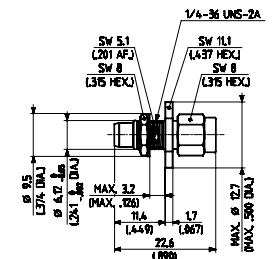

VSWR: DC - 18 GHz:  $\leq 1.05 + 0.005f$

**3** H+S type Item no. 33\_BMA-SMA-50-1/199\_UE 22645644

BMA plug (m)  
SMA jack (f)

Packaging single

Material BMA stainless steel  
SMA stainless steel

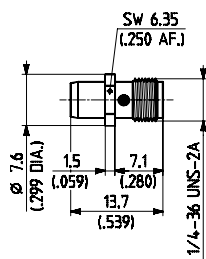

VSWR: DC - 18 GHz:  $\leq 1.06 + 0.009f$

**7** H+S type Item no. 36\_BMA-SMA-50-1/199\_UE 22645651

BMA plug (m)  
SMA jack (f)

Packaging single

Material BMA stainless steel  
SMA stainless steel  
Mounting hole ML 56

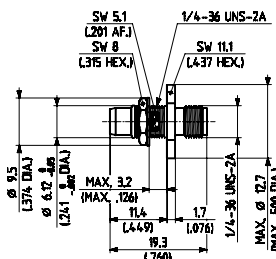

VSWR: DC - 18 GHz:  $\leq 1.03 + 0.015f$

**4** H+S type Item no. 33\_SMA-BMA-50-1/1-9\_UE 22645645

SMA plug (m)  
BMA jack (f)

Packaging single

Material SMA stainless steel  
BMA stainless steel

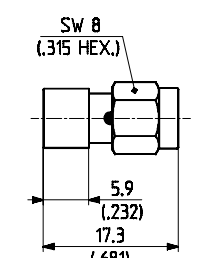

VSWR: DC - 18 GHz:  $\leq 1.06 + 0.009f$

**8** H+S type Item no. 37\_BMA-SMA-50-1/1\_UE 22645649

BMA jack (f)  
SMA jack (f)

Packaging single

Material BMA stainless steel  
SMA stainless steel  
Mounting Hole ML 58

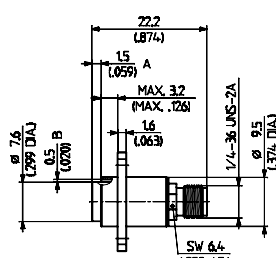

VSWR: DC - 9 GHz:  $\leq 1.07 + 0.017f$   
9 - 18 GHz:  $\leq 1.22$

**9** H+S type Item no. **31\_BNC-MMCX-50-1/1-UE** 22645963

**BNC** jack (f)  
**MMCX** jack (f)

Packaging single

Material  
BNC brass/SUCO\*  
MMCX brass/gold

VSWR: DC - 4 GHz:  $\leq 1.05 + 0.04f$

**13** H+S type Item no. **33\_MMCX-BNC-50-1/111\_UE** 22645966

**MMCX** plug (m)  
**BNC** jack (f)

Packaging single

Material  
MMCX brass/gold  
BNC brass/SUCO\*

VSWR: DC - 4 GHz:  $\leq 1.05 + 0.04f$

**10** H+S type Item no. **32\_BNC-MMCX-50-1/1-UE** 22645959

**BNC** plug (m)  
**MMCX** plug (m)

Packaging single

Material  
BNC brass/SUCO\*  
MMCX brass/gold

VSWR: DC - 4 GHz:  $\leq 1.03 + 0.05f$

**14** H+S type Item no. **35\_BNC-MMCX-50-2/1-NE** 23005885

**BNC** plug (m)  
**MMCX** plug (m)

Packaging single

Material  
BNC brass/SUCO\*  
MMCX brass/gold  
Mounting hole ML 2

VSWR: DC - 1 GHz:  $\leq 1.03$ ; 1 - 3 GHz:  $\leq 0.935 + 0.095f$ ; 3 - 4 GHz:  $\leq 1.22$

**11** H+S type Item no. **33\_BNC-MMCX-50-1/1-NE** 22652907

**BNC** plug (m)  
**MMCX** jack (f)

Packaging single

Material  
BNC brass/SUCO\*  
MMCX brass/gold

VSWR: DC - 4 GHz:  $\leq 1.03 + 0.05f$

**15** H+S type Item no. **31\_BNC-MCX-50-1/1-UE** 22543639

**BNC** jack (f)  
**MCX** jack (f)

Packaging single

Material  
BNC brass/SUCO\*  
MCX brass/gold

VSWR: DC - 2 GHz:  $\leq 1.03 + 0.13f$   
2 - 4 GHz:  $\leq 1.29$

**12** H+S type Item no. **33\_BNC-MMCX-50-1/1-UE** 22645964

**BNC** plug (m)  
**MMCX** jack (f)

Packaging single

Material  
BNC brass/SUCO\*  
MMCX brass/SUCO\*

VSWR: DC - 4 GHz:  $\leq 1.05 + 0.025f$

**16** H+S type Item no. **32\_BNC-MCX-50-1/1-UE** 22543567

**BNC** plug (m)  
**MCX** plug (m)

Packaging single

Material  
BNC brass/SUCO\*  
MCX CuBe/gold

VSWR: DC - 2 GHz:  $\leq 1.04 + 0.09f$   
2 - 4 GHz:  $\leq 1.22$

**17** H+S type Item no. **33\_BNC-MCX-50-1/1-UE**  
22543829

**BNC MCX** plug (m) jack (f)

Packaging: single

Material:  
BNC: brass/SUCO\*  
MCX: brass/gold

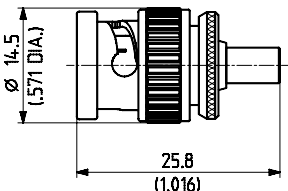

VSWR: DC - 4 GHz: ≤ 1.20

**21** H+S type Item no. **34\_BNC-MCX-50-2/133\_UE**  
22644912

**BNC MCX** jack (f) jack (f)

Packaging: single

Material:  
BNC: brass/SUCO\*  
MCX: brass/SUCO\*  
Mounting hole: ML 2

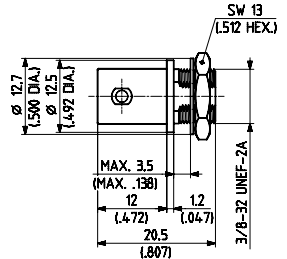

VSWR: DC - 4 GHz: ≤ 1.03 + 0.04f

**18** H+S type Item no. **33\_BNC-MCX-75-1/1-NE**  
22649213

**BNC MCX** plug (m) jack (f)

Packaging: single

Material:  
BNC: brass/SUCO\*  
MCX: brass/gold

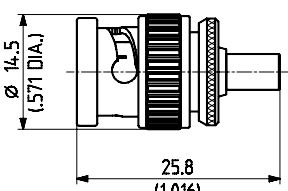

**22** H+S type Item no. **31\_BNC-N-50-1/133\_UE**  
22540549

**BNC N** jack (f) jack (f)

Packaging: single

Material:  
BNC: brass/SUCO\*  
N: brass/SUCO\*

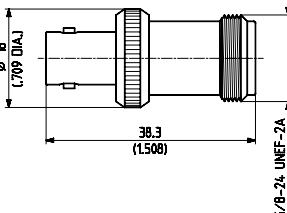

VSWR: DC - 4 GHz: ≤ 1.22

**19** H+S type Item no. **33\_MCX-BNC-50-1/1-UE**  
22543585

**MCX BNC** plug (m) jack (f)

Packaging: single

Material:  
MCX: CuBe/gold  
BNC: brass/SUCO\*

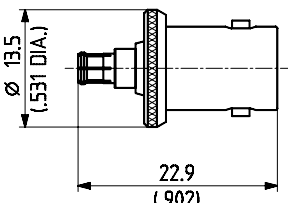

VSWR: DC - 1 GHz: ≤ 1.04; 1 - 4 GHz: ≤ 1.22

**23** H+S type Item no. **31\_BNC-N-75-1/133\_UE**  
22543640

**BNC N** jack (f) jack (f)

Packaging: single

Material:  
BNC: brass/SUCO\*  
N: brass/SUCO\*

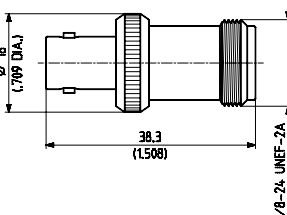

**20** H+S type Item no. **33\_MCX-BNC-75-1/1-NE**  
22649211

**MCX BNC** plug (m) jack (f)

Packaging: single

Material:  
MCX: CuBe/gold  
BNC: brass/SUCO\*

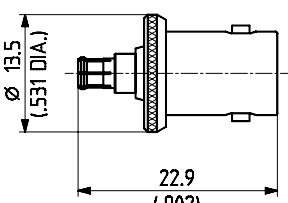

**24** H+S type Item no. **32\_BNC-N-50-1/133\_UE**  
22540571

**BNC N** plug (m) plug (m)

Packaging: single

Material:  
BNC: brass/SUCO\*  
N: brass/SUCO\*

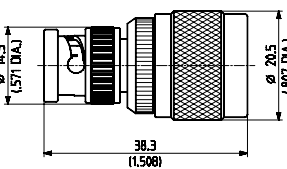

VSWR: DC - 4 GHz: ≤ 1.06 + 0.4f

Material and plating descriptions may refer to the connector housing or outer contact.

SUCO\* = SUCOPLATE®  
SUPR\*\* = SUCOPRO

**25** H+S type Item no. **32\_BNC-N-75-1/133\_UE** 22541022

**BNC N** plug (m) plug (m)

Packaging: single

Material: BNC N brass/SUCO\* brass/SUCO\*

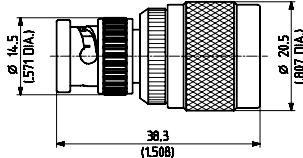

**29** H+S type Item no. **33\_N-BNC-75-1/133\_UE** 22542622

**N BNC** plug (m) jack (f)

Packaging: single

Material: N BNC brass/SUCO\* brass/SUCO\*

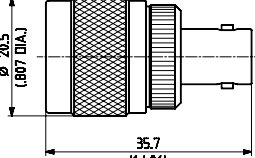

**26** H+S type Item no. **33\_BNC-N-50-1/133\_NE** 22540608

**BNC N** plug (m) jack (f)

Packaging: single

Material: BNC N brass/SUCO\* brass/SUCO\*

VSWR: DC - 4 GHz:  $\leq 1.04 + 0.025f$

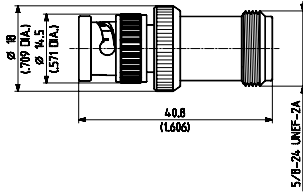

**30** H+S type Item no. **34\_BNC-N-50-1/133\_UE** 22651055

**BNC N** jack (f) jack (f)

Packaging: single

Material: BNC N brass/SUCO\* brass/SUCO\* Mounting hole ML 12

VSWR: DC - 4 GHz:  $\leq 1.22$

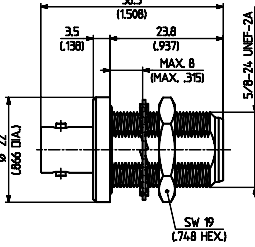

**27** H+S type Item no. **33\_BNC-N-75-1/133\_UE** 22541034

**BNC N** plug (m) jack (f)

Packaging: single

Material: BNC N brass/SUCO\* brass/SUCO\*

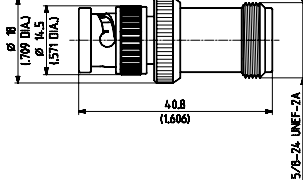

**31** H+S type Item no. **33\_BNC-QLA-01-1/1-NE** 22540624

**BNC QLA 00** plug (m) jack (f)

Packaging: single

Material: BNC QLA 00 brass/nickel brass/nickel

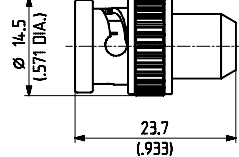

**28** H+S type Item no. **33\_N-BNC-50-1/133\_UE** 22542414

**N BNC** plug (m) jack (f)

Packaging: single

Material: N BNC brass/SUCO\* brass/SUCO\*

VSWR: DC - 4 GHz:  $\leq 1.22$

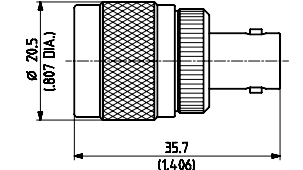

**32** H+S type Item no. **33\_QLA-BNC-01-1/1-NE** 22640029

**QLA 00 BNC** plug (m) jack (f)

Packaging: single

Material: QLA 00 BNC brass/nickel brass/SUCO\*

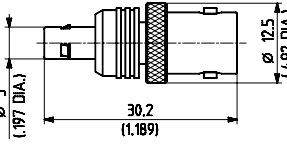

**33** H+S type Item no. **34\_BNC-QLA-01-1/1-UE** 22640971

**BNC QLA 00** jack (f) jack (f)

Packaging single

Material: BNC brass/SUCO\* QLA 00 brass/SUCO\* Mounting hole ML 2

**37** H+S type Item no. **33\_SMA-BNC-50-1/1-NE** 22640153

**SMA BNC** plug (m) jack (f)

Packaging single

Material: SMA CuBe/gold BNC brass/SUCO\*

VSWR: DC - 4 GHz:  $\leq 1.05 + 0.037f$

**34** H+S type Item no. **31\_BNC-SMA-50-1/1-UE** 22540551

**BNC SMA** jack (f) jack (f)

Packaging single

Material: BNC brass/SUCO\* SMA CuBe/gold

VSWR: DC - 4 GHz:  $\leq 1.06 - 0.04f$

**38** H+S type Item no. **34\_BNC-SMA-50-2/1-UE** 22640153

**BNC SMA** jack (f) jack (f)

Packaging single

Material: BNC brass/SUCO\* SMA CuBe/gold Mounting hole ML 4

VSWR: DC - 4 GHz:  $\leq 1.06 + 0.03f$

**35** H+S type Item no. **32\_BNC-SMA-50-1/1-UE** 22540572

**BNC SMA** plug (m) plug (m)

Packaging single

Material: BNC brass/SUCO\* SMA CuBe/gold

VSWR: DC - 4 GHz:  $\leq 1.03 + 0.03f$

**39** H+S type Item no. **31\_BNC-SMB-50-2/1-UE** 22540553

**BNC SMB** jack (f) jack (f)

Packaging single

Material: BNC brass/SUCO\* SMB brass/gold

VSWR: DC - 2 GHz:  $\leq 1.03 + 0.095f$   
2 - 4 GHz:  $\leq 1.22$

**36** H+S type Item no. **33\_BNC-SMA-50-1/1-UE** 22540610

**BNC SMA** plug (m) jack (f)

Packaging single

Material: BNC brass/SUCO\* SMA CuBe/gold

VSWR: DC - 4 GHz:  $\leq 1.03 + 0.03f$

**40** H+S type Item no. **32\_BNC-SMB-50-2/1-UE** 22540574

**BNC SMB** plug (m) plug (m)

Packaging single

Material: BNC brass/SUCO\* SMB brass/gold

VSWR: DC - 4 GHz:  $\leq 1.12$

Material and plating descriptions may refer to the connector housing or outer contact.

SUCO\* = SUCOPLATE®  
SUPR\*\* = SUCOPRO



**41** H+S type Item no. **33\_BNC-SMB-50-2/1-UE**  
22540612

**BNC SMB** plug (m) jack (f)

Packaging: single

Material:  
BNC: brass/SUCO\*  
SMB: brass/gold

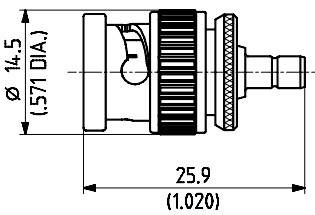

VSWR: DC - 4 GHz:  $\leq 1.06 + 0.04f$

**45** H+S type Item no. **32\_BNC-SMC-50-2/1-NE**  
22540576

**BNC SMC** plug (m) plug (m)

Packaging: single

Material:  
BNC: brass/SUCO\*  
SMC: brass/gold

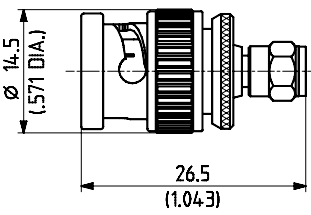

VSWR: DC - 4 GHz:  $\leq 1.15$

**42** H+S type Item no. **33\_SMB-BNC-50-2/1-UE**  
22640396

**SMB BNC** plug (m) jack (f)

Packaging: single

Material:  
SMB: brass/gold  
BNC: brass/SUCO\*

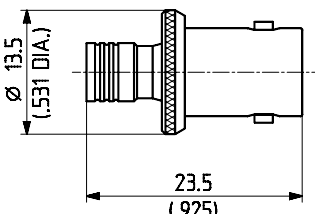

VSWR: DC - 4 GHz:  $\leq 1.05 + 0.075f$

**46** H+S type Item no. **33\_BNC-SMC-50-2/1-NE**  
22540616

**BNC SMC** plug (m) jack (f)

Packaging: single

Material:  
BNC: brass/SUCO\*  
SMC: brass/gold

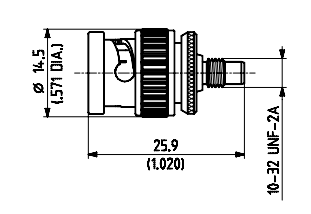

VSWR: DC - 4 GHz:  $\leq 1.22$

**43** H+S type Item no. **34\_BNC-SMB-50-1/133\_NH**  
23001709

**BNC SMB** jack (f) jack (f)

Packaging: bulk 100 pcs.

Material:  
BNC: brass/SUCO\*  
SMB: brass/SUCO\*  
Mounting hole: ML 4

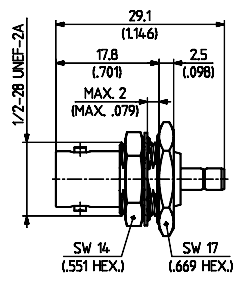

VSWR: DC - 2 GHz:  $\leq 1.065$   
2 - 4 GHz:  $\leq 0.8 + 0.13f$

**47** H+S type Item no. **33\_SMC-BNC-50-2/1-NE**  
22640405

**SMC BNC** plug (m) jack (f)

Packaging: single

Material:  
SMC: brass/gold  
BNC: brass/SUCO\*

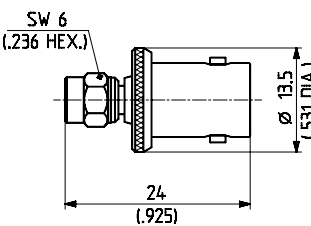

VSWR: DC - 2 GHz:  $\leq 1.03 + 0.095f$   
2 - 4 GHz:  $\geq 1.22$

**44** H+S type Item no. **31\_BNC-SMC-50-2/1-NE**  
22540555

**BNC SMC** jack (f) jack (f)

Packaging: single

Material:  
BNC: brass/SUCO\*  
SMC: brass/gold

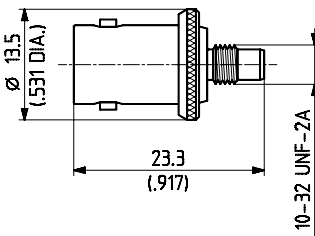

VSWR: DC - 4 GHz:  $\leq 1.22$

**48** H+S type Item no. **31\_BNC-TNC-50-1/133\_UE**  
22540559

**BNC TNC** jack (f) jack (f)

Packaging: single

Material:  
BNC: brass/SUCO\*  
TNC: brass/SUCO\*

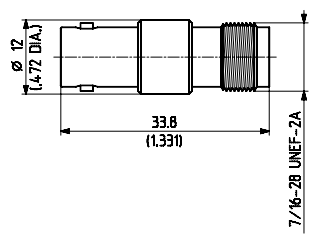

VSWR: DC - 4 GHz:  $\leq 1.22$

**49** H+S type Item no. **32\_BNC-TNC-50-1/133\_NE**  
22540582

**BNC TNC** plug (m)  
plug (m)

Packaging: single

Material:  
BNC: brass/SUCO\*  
TNC: brass/SUCO\*

VSWR: DC - 4 GHz: ≤ 1.22

**53** H+S type Item no. **37\_BNC-TNC-50-1/133\_UE**  
22540639

**BNC TNC** jack (f)  
jack (f)

Packaging: single

Material:  
BNC: brass/SUCO\*  
TNC: brass/SUCO\*

VSWR: DC - 4 GHz: ≤ 1.22

**50** H+S type Item no. **33\_BNC-TNC-50-1/133\_NE**  
22540614

**BNC TNC** plug (m)  
jack (f)

Packaging: single

Material:  
BNC: brass/SUCO\*  
TNC: brass/SUCO\*

VSWR: DC - 4 GHz: ≤ 1.22

**54** H+S type Item no. **31\_MMBX-SMA-50-1/111\_NE**  
23004933

**MMBX SMA** jack (f)  
jack (f)

Packaging: single

Material:  
MMBX: brass/SUPR\*\*  
SMA: CuBe/SUPR\*\*

VSWR: DC - 2.5 GHz: ≤ 1.05; 2.5 - 6 GHz: ≤ 1.06  
6 - 12.4 GHz: ≤ 1.35

**51** H+S type Item no. **33\_TNC-BNC-50-1/133\_NE**  
22640631

**TNC BNC** plug (m)  
jack (f)

Packaging: single

Material:  
TNC: brass/SUCO\*  
BNC: brass/SUCO\*

VSWR: DC - 4 GHz: ≤ 1.22

**55** H+S type Item no. **32\_MMBX-SMA-50-1/119\_NE**  
23004934

**MMBX SMA** plug (m)  
plug (m)

Packaging: single

Material:  
MMBX: CuBe/SUPR\*\*  
SMA: CuBe/SUPR\*\*

VSWR: DC - 2.5 GHz: ≤ 1.05; 2.5 - 6 GHz: ≤ 1.06  
6 - 12.4 GHz: ≤ 1.35

**52** H+S type Item no. **33\_TNC-BNC-75-1/133\_UE**  
22640759

**TNC BNC** plug (m)  
jack (f)

Packaging: single

Material:  
TNC: brass/SUCO\*  
BNC: brass/SUCO\*

VSWR: DC - 4 GHz: ≤ 1.22

**56** H+S type Item no. **33\_MMBX-SMA-50-1/111\_NE**  
23004937

**MMBX SMA** plug (m)  
jack (f)

Packaging: single

Material:  
MMBX: CuBe/SUPR\*\*  
SMA: CuBe/SUPR\*\*

VSWR: DC - 2.5 GHz: ≤ 1.05; 2.5 - 6 GHz: ≤ 1.06  
6 - 12.4 GHz: ≤ 1.35

Material and plating descriptions may refer to the connector housing or outer contact. SUCO\* = SUCOPLATE®  
SUPR\*\* = SUCOPRO

**57** H+S type Item no. 33\_SMA-MMBX-50-1/119\_NE 23004935

**SMA MMBX** plug (m) jack (f)

Packaging: single

Material: SMA: CuBe/SUPR\*\*  
MMBX: brass/SUPR\*\*

VSWR: DC - 2.5 GHz: ≤ 1.05; 2.5 - 6 GHz: ≤ 1.06  
6 - 12.4 GHz: ≤ 1.35

**61** H+S type Item no. 33\_MMCX-SMA-50-1/111\_UE 22645970

**MMCX SMA** plug (m) jack (f)

Packaging: single

Material: MMCX: brass/gold  
SMA: CuBe/gold

VSWR: DC - 2.5 GHz: ≤ 1.10  
2.5 - 6 GHz: ≤ 1.18

**58** H+S type Item no. 34\_MMBX-TNC-50-1/1-3\_NE 23014297

**MMBX TNC** jack (f) jack (f)

Packaging: single

Material: MMBX: brass/SUCO\*  
TNC: brass/SUCO\*

VSWR: DC - 5 GHz: ≤ 1.3

**62** H+S type Item no. 33\_SMA-MMCX-50-1/111\_NE 22645969

**SMA MMCX** plug (m) jack (f)

Packaging: single

Material: SMA: CuBe/gold  
MMCX: brass/gold

VSWR: DC - 2.5 GHz: ≤ 1.10  
2.5 - 6 GHz: ≤ 1.18

**59** H+S type Item no. 31\_MMCX-SMA-50-1/111\_OE 22645961

**MMCX SMA** jack (f) jack (f)

Packaging: single

Material: MMCX: brass/gold  
SMA: CuBe/gold

VSWR: DC - 2.5 GHz: ≤ 1.10  
2.5 - 6 GHz: ≤ 1.18

**63** H+S type Item no. 31\_MCX-N-50-1/1-UE 22640172

**MCX N** jack (f) jack (f)

Packaging: single

Material: MCX: brass/gold  
N: brass/SUCO\*

VSWR: DC - 6 GHz: ≤ 1.03 + 0.05f

**60** H+S type Item no. 32\_MMCX-SMA-50-1/111\_OE 22645967

**MMCX SMA** plug (m) plug (m)

Packaging: single

Material: MMCX: brass/gold  
SMA: CuBe/gold

VSWR: DC - 2.5 GHz: ≤ 1.10  
2.5 - 6 GHz: ≤ 1.18

**64** H+S type Item no. 31\_MCX-N-75-10/133\_NE 22651488

**MCX N** jack (f) jack (f)

Packaging: single

Material: MCX: CuBe/SUCO\*  
N: brass/SUCO\*

VSWR: DC - 3 GHz: ≤ 1.07

Material and plating descriptions may refer to the connector housing or outer contact.

SUCO\* = SUCOPLATE®  
SUPR\*\* = SUCOPRO

**65** H+S type Item no. 32\_MCX-N-50-1/1\_UE 22543584

MCX N plug (m) plug (m)

Packaging single

Material: MCX N CuBe/gold brass/SUCO\*

VSWR: DC - 6 GHz:  $\leq 1.03 + 0.05f$

**69** H+S type Item no. 34\_MCX-N-50-1/133\_UE 22646217

MCX N jack (f) jack (f)

Packaging single

Material: MCX N brass/SUCO\* brass/SUCO\*

Mounting hole: ML 4

VSWR: DC - 6 GHz:  $\leq 1.03 + 0.03f$

**66** H+S type Item no. 33\_MCX-N-50-1/1\_UE 22543586

MCX N plug (m) jack (f)

Packaging single

Material: MCX N CuBe/gold brass/SUCO\*

VSWR: DC - 6 GHz:  $\leq 1.03 + 0.035f$

**70** H+S type Item no. 31\_MCX-SMA-50-1/111\_NE 22645485

MCX SMA jack (f) jack (f)

Packaging single

Material: MCX SMA brass/gold CuBe/gold

VSWR: DC - 6 GHz:  $\leq 1.03 - 0.03f$

**67** H+S type Item no. 33\_N-MCX-50-1/1\_UE 22543796

N MCX plug (m) jack (f)

Packaging single

Material: N MCX brass/SUCO\* brass/gold

VSWR: DC - 6 GHz:  $\leq 1.03 + 0.03f$

**71** H+S type Item no. 32\_MCX-SMA-50-1/111\_NE 22645486

MCX SMA plug (m) plug (m)

Packaging single

Material: MCX SMA brass/gold CuBe/gold

VSWR: DC - 6 GHz:  $\leq 1.03 + 0.03f$

**68** H+S type Item no. 33\_N-MCX-75-1/1\_UE 22649214

N MCX plug (m) jack (f)

Packaging single

Material: N MCX brass/SUCO\* brass/gold

VSWR: DC - 6 GHz:  $\leq 1.03 + 0.03f$

**72** H+S type Item no. 33\_MCX-SMA-50-1/111\_UE 22645487

MCX SMA plug (m) jack (f)

Packaging single

Material: MCX SMA CuBe/gold CuBe/gold

VSWR: DC - 6 GHz:  $\leq 1.03 + 0.03f$

Material and plating descriptions may refer to the connector housing or outer contact.

SUCO\* = SUCOPLATE®  
SUPR\*\* = SUCOPRO

**73** H+S type Item no. 33\_SMA-MCX-50-1/111\_NE 22645488

**SMA MCX** plug (m) jack (f)

Packaging: single

Material: SMA: CuBe/gold, MCX: brass/gold

SW 8 (.315 HEX.)

24.1 (.949)

VSWR: DC - 6 GHz:  $\leq 1.03 + 0.03f$

**77** H+S type Item no. 32\_N-QN-50-1/133\_NE 23033962

**N QN** plug (m) plug (m)

Packaging: single

Material: N: brass/SUCO\*, QN: brass/SUCO\*

SW 19 (.748 HEX.)

$\phi$  21 (.827 DIA.)

29.6 (1.165)

$\phi$  19 (.748 DIA.)

VSWR: DC - 4 GHz:  $\leq 1.035$ ; 4 - 8 GHz:  $\leq 1.06$ ; 8 - 10 GHz:  $\leq 1.22$

**74** H+S type Item no. 34\_MCX-TNC-50-1/133\_UE 22641905

**MCX TNC** jack (f) jack (f)

Packaging: single

Material: MCX: brass/SUCO\*, TNC: brass/SUCO\*

Mounting hole: ML 2

SW 13 (.512 HEX.)

MAX. 3.5 (MAX. .138)

12 (.472)

12 (.472)

12 (.472)

20.5 (.807)

3/8-32 UNEF-2A

7/16-28 UNEF-2A

$\phi$  12.5 (.492 DIA.)

$\phi$  12.7 (5.00 DIA.)

VSWR: DC - 6 GHz:  $\leq 1.07 + 0.07f$

**78** H+S type Item no. 31\_N-SMA-50-1/1-UE 22542386

**N SMA** jack (f) jack (f)

Packaging: single

Material: N: brass/SUCO\*, SMA: CuBe/gold

28.9 (1.138)

1/4-36 UNS-2A

$\phi$  16 (.430 DIA.)

5/8-24 UNEF-2A

VSWR: DC - 12.4 GHz:  $\leq 1.05 + 0.015f$

**75** H+S type Item no. 33\_N-QLA-01-1/1-NE 22542431

**N QLA 00** plug (m) jack (f)

Packaging: single

Material: N: brass/SUCO\*, QLA 00: brass/nickel

33.4 (1.315)

$\phi$  20.5 (.807 DIA.)

**79** H+S type Item no. 32\_N-SMA-50-1/11-NE 22542399

**N SMA** plug (m) plug (m)

Packaging: single

Material: N: brass/SUCO\*, SMA: CuBe/gold

SW 14 (.551 AF.)

SW 8 (.315 HEX.)

$\phi$  20.5 (.807 DIA.)

28.3 (1.114)

VSWR: DC - 12.4 GHz:  $\leq 1.05 + 0.017f$

**76** H+S type Item no. 31\_N-QN-50-1/133\_NE 84016830

**N QN** jack (f) jack (f)

Packaging: single

Material: N: brass/SUCO\*, QN: brass/SUCO\*

38.08 (1.497)

$\phi$  18.5 (.685 DIA.)

5/8-24 UNEF-2A

VSWR: DC - 2 GHz: 1.05; 2 - 6 GHz: 1.3; 6 - 11 GHz: 1.5

**80** H+S type Item no. 33\_N-SMA-50-1/113\_UE 22542421

**N SMA** plug (m) jack (f)

Packaging: single

Material: N: brass/SUCO\*, SMA: CuBe/gold

SW 14 (.551 AF.)

$\phi$  20.5 (.807 DIA.)

27.6 (1.087)

1/4-36 UNS-2A

VSWR: DC - 12.4 GHz:  $\leq 1.05 + 0.015f$

Material and plating descriptions may refer to the connector housing or outer contact.

SUCO\* = SUCOPLATE®  
SUPR\*\* = SUCOPRO

**81** H+S type Item no. 33\_SMA-N-50-1/1\_UE 22640154

**SMA N** plug (m) jack (f)

Packaging: single

Material: SMA N: CuBe/gold, brass/SUCO\*

VSWR: DC - 12.4 GHz:  $\leq 1.05 + 0.015f$

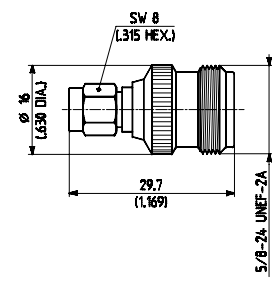

**85** H+S type Item no. 31\_N-SMB-50-1/1\_UE 22542387

**N SMB** jack (f) jack (f)

Packaging: single

Material: N SMB: brass/SUCO\*, brass/gold

VSWR: DC - 3 GHz:  $\leq 1.03 + 0.08f$   
3 - 4 GHz:  $\leq 1.27$

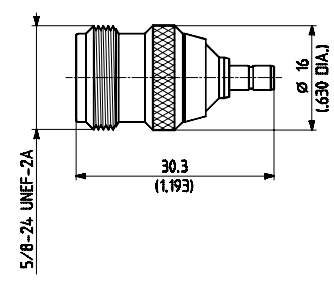

**82** H+S type Item no. 34\_N-SMA-50-1/193\_UE 22642820

**N SMA** jack (f) jack (f)

Packaging: single

Material: N SMA: stainless steel, stainless steel, Mounting hole ML 12

VSWR: DC - 12.4 GHz:  $\leq 1.05 + 0.017f$

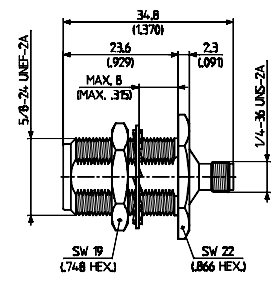

**86** H+S type Item no. 32\_N-SMB-50-1/1\_UE 22542400

**N SMB** plug (m) plug (m)

Packaging: single

Material: N SMB: brass/SUCO\*, brass/gold

VSWR: DC - 4 GHz:  $\leq 1.03 + 0.04f$

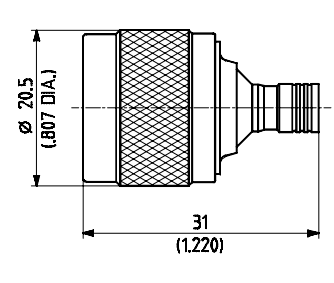

**83** H+S type Item no. 37\_N-SMA-50-1/1\_UE 22543458

**N SMA** jack (f) jack (f)

Packaging: single

Material: N SMA: brass/SUCO\*, CuBe/gold, Mounting hole ML 13/14

VSWR: DC - 12.4 GHz:  $\leq 1.05 + 0.015f$

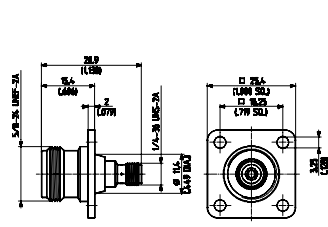

**87** H+S type Item no. 33\_N-SMB-50-1/1\_UE 22542422

**N SMB** plug (m) jack (f)

Packaging: single

Material: N SMB: brass/SUCO\*, brass/gold

VSWR: DC - 3 GHz:  $\leq 1.03 + 0.08f$   
3 - 4 GHz:  $\leq 1.27$

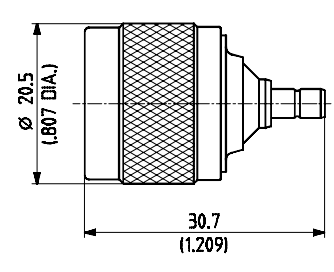

**84** H+S type Item no. 39\_SMA-N-50-1/1\_UE 22640156

**SMA N** plug (m) jack (f)

Packaging: single

Material: SMA N: CuBe/gold, brass/SUCO\*, Mounting hole ML 13/14

VSWR: DC - 12.4 GHz:  $\leq 1.05 + 0.015f$

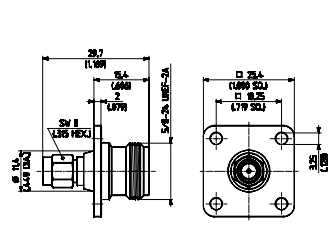

**88** H+S type Item no. 33\_SMB-N-50-1/1\_UE 22640394

**SMB N** plug (m) jack (f)

Packaging: single

Material: SMB N: brass/gold, brass/SUCO\*

VSWR: DC - 4 GHz:  $\leq 1.06 + 0.04f$

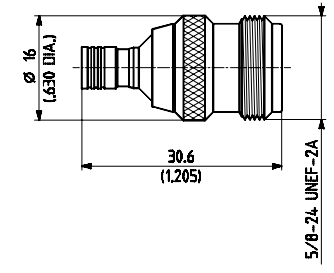

Material and plating descriptions may refer to the connector housing or outer contact. SUCO\* = SUCOPLATE® SUPR\*\* = SUCOPRO

**89** H+S type  
Item no. **34\_N-SMB-50-1/1-UE**  
22642272

**N**  
**SMB** jack (f)  
jack (f)

Packaging single

Material:  
N brass/SUCO\*  
SMB brass/gold  
Mounting hole ML 12

VSWR: DC - 4 GHz:  $\leq 1.22$

**93** H+S type  
Item no. **33\_N-SMC-50-1/1-NE**  
22542423

**N**  
**SMC** plug (m)  
jack (f)

Packaging single

Material:  
N brass/SUCO\*  
SMC brass/SUCO\*

VSWR: DC - 2 GHz:  $\leq 1.10$ ; 2 - 4 GHz:  $\leq 1.20$   
4 - 10 GHz:  $\leq 1.40$

**90** H+S type  
Item no. **37\_N-SMB-50-1/1-UE**  
22641514

**N**  
**SMB** jack (f)  
jack (f)

Packaging single

Material:  
N brass/SUCO\*  
SMB brass/gold  
Mounting hole ML 14

VSWR: DC - 4 GHz:  $\leq 1.06 + 0.08f$

**94** H+S type  
Item no. **33\_SMC-N-50-1/1-NE**  
22640406

**SMC**  
**N** plug (m)  
jack (f)

Packaging single

Material:  
SMC brass/gold  
N brass/SUCO\*

VSWR: DC - 2 GHz:  $\leq 1.10$ ; 2 - 4 GHz:  $\leq 1.20$   
4 - 10 GHz:  $\leq 1.40$

**91** H+S type  
Item no. **31\_N-SMC-50-1/1-NE**  
22542389

**N**  
**SMC** jack (f)  
jack (f)

Packaging single

Material:  
N brass/SUCO\*  
SMC brass/gold

VSWR: DC - 2 GHz:  $\leq 1.10$ ; 2 - 4 GHz:  $\leq 1.20$   
4 - 10 GHz:  $\leq 1.40$

**95** H+S type  
Item no. **37\_N-SMC-50-1/1-UE**  
22641154

**N**  
**SMC** jack (f)  
jack (f)

Packaging single

Material:  
N brass/SUCO\*  
SMC brass/gold  
Mounting hole: ML 14

VSWR: DC - 10 GHz:  $\leq 1.06 + 0.084$

**92** H+S type  
Item no. **32\_N-SMC-50-1/1-NE**  
22542402

**N**  
**SMC** plug (m)  
plug (m)

Packaging single

Material:  
N brass/SUCO\*  
SMC brass/gold

VSWR: DC - 2 GHz:  $\leq 1.10$ ; 2 - 4 GHz:  $\leq 1.20$   
4 - 10 GHz:  $\leq 1.40$

**96** H+S type  
Item no. **31\_N-TNC-50-1/133\_UE**  
22542392

**N**  
**TNC** jack (f)  
jack (f)

Packaging single

Material:  
N brass/SUCO\*  
TNC brass/SUCO\*

VSWR: DC - 7 GHz:  $\leq 1.06 + 0.12f$   
7 - 11 GHz:  $\leq 1.90$

**97** H+S type Item no. **32\_N-TNC-50-1/-\_UE** 22542406

**N**  
**TNC**  
Packaging: single  
Material: N  
TNC: brass/SUCO\*  
brass/SUCO\*

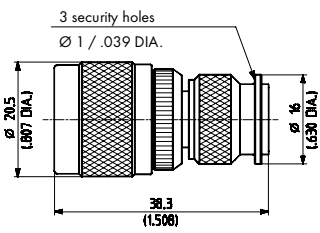

VSWR: DC - 11 GHz:  $\leq 1.06 + 0.11f$

**101** H+S type Item no. **31\_N-716-50-1/-\_UE** 22640869

**N**  
**7/16**  
Packaging: single  
Material: N  
7/16: brass/SUCO\*  
brass/SUCO\*

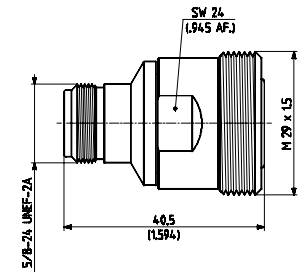

VSWR: DC - 7.5 GHz:  $\leq 1.03 + 0.02f$

**98** H+S type Item no. **33\_N-TNC-50-1/133\_NE** 22542427

**N**  
**TNC**  
Packaging: single  
Material: N  
TNC: brass/SUCO\*  
brass/SUCO\*

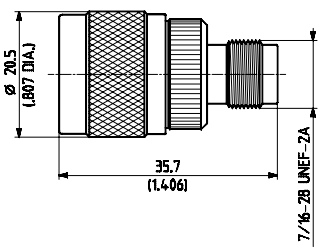

VSWR: DC - 11 GHz:  $\leq 1.13 + 0.02f$

**102** H+S type Item no. **32\_N-716-50-1/-\_NE** 22544576

**N**  
**7/16**  
Packaging: single  
Material: N  
7/16: brass/SUCO\*  
brass/silver

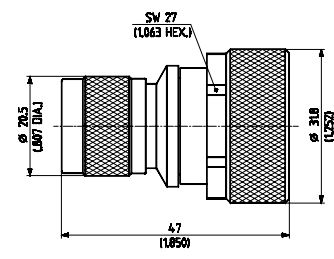

VSWR: DC - 7.5 GHz:  $\leq 1.03 + 0.02f$

**99** H+S type Item no. **33\_TNC-N-50-1/133\_UE** 22640637

**TNC**  
**N**  
Packaging: single  
Material: TNC  
N: brass/SUCO\*  
brass/SUCO\*

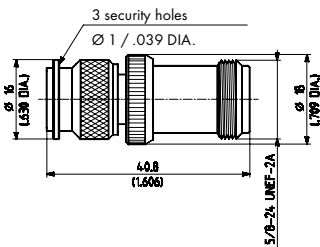

VSWR: DC - 3 GHz:  $\leq 1.05$ ; 3 - 5.5 GHz:  $\leq 1.18$   
5.5 - 11 GHz:  $\leq 2.00$

**103** H+S type Item no. **33\_N-716-50-1/-\_UE** 22641229

**N**  
**7/16**  
Packaging: single  
Material: N  
7/16: brass/SUCO\*  
brass/silver

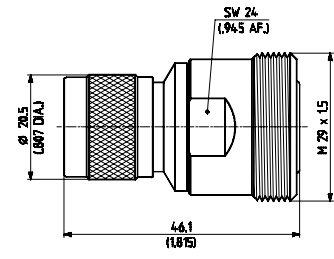

VSWR: DC - 7.5 GHz:  $\leq 1.03 + 0.02f$

**100** H+S type Item no. **33\_TNC-N-75-1/133\_UE** 22658811

**TNC**  
**N**  
Packaging: single  
Material: TNC  
N: brass/SUCO\*  
brass/SUCO\*

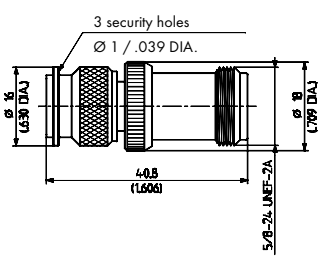

VSWR: DC - 7.5 GHz:  $\leq 1.03 + 0.02f$

**104** H+S type Item no. **33\_716-N-50-1/-\_UE** 22544119

**7/16**  
**N**  
Packaging: single  
Material: 7/16  
N: brass/silver  
brass/SUCO\*

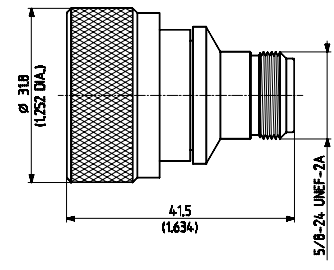

VSWR: DC - 7.5 GHz:  $\leq 1.03 + 0.02f$



**105** H+S type Item no. 37\_N-716-50-1/003\_E 23001317

**N** jack (f)  
**7/16** jack (f)

Packaging single

Material:  
N brass/silver  
7/16 brass/silver  
Mounting hole ML 27

VSWR: DC - 7.5 GHz:  $\leq 1.03 + 0.02f$

**109** H+S type Item no. 39\_QMA-SMA-U50-1/11-\_NE 23022741

**QMA** plug (m)  
**SMA** jack (f)

Packaging single

Material:  
QMA stainless steel  
SMA CuBe/SUPR\*\*  
Mounting hole ML 58

VSWR: DC - 2 GHz:  $\leq 1.04$ ; 2 - 4 GHz:  $\leq 1.05$   
4 - 6 GHz:  $\leq 1.08$

**106** H+S type Item no. 33\_QN-N-50-1/133\_NE 23036033

**QN** plug (m)  
**N** jack (f)

Packaging single

Material:  
QN brass/SUCO\*  
N brass/SUCO\*

VSWR: DC - 1 GHz: 1.02  
1 - 2.5 GHz: 1.04  
2.5 - 11 GHz: 1.15

**110** H+S type Item no. 33\_SMA-QMA-50-1/133\_NE 84012204

**SMA** plug (m)  
**QMA** jack (f)

Packaging single

Material:  
SMA brass/SUCO\*  
QMA brass/SUCO\*

VSWR: DC - 4 GHz: 1.05  
4 - 6 GHz: 1.17

**107** H+S type Item no. 39\_QN-PC35-U50-1/19\_NE 23033936

**QN** plug (m)  
**PC35** jack (f)

Packaging single

Material:  
QN stainless steel  
PC35 stainless steel

VSWR: DC - 2.5 GHz:  $\leq 1.035$ ; 2.5 - 6 GHz:  $\leq 1.12$   
6 - 11 GHz:  $\leq 1.22$

**111** H+S type Item no. 31\_SMA-SMB-50-1/111\_UE 22641728

**SMA** jack (f)  
**SMB** jack (f)

Packaging single

Material:  
SMA CuBe/gold  
SMB brass/gold

VSWR: DC - 4 GHz:  $\leq 1.05 + 0.04f$

**108** H+S type Item no. 33\_QMA-SMA-50-1/133\_NE 84014876

**QMA** plug (m)  
**SMA** jack (f)

Packaging single

Material:  
QMA brass/SUCO\*  
SMA brass/SUCO\*

VSWR: DC - 4 GHz: 1.05  
4 - 6 GHz: 1.17

**112** H+S type Item no. 33\_SMA-SMB-50-1/111\_NE 22658917

**SMA** plug (m)  
**SMB** jack (f)

Packaging single

Material:  
SMA brass/gold  
SMB brass/gold

VSWR: DC - 4 GHz:  $\leq 1.05 + 0.04 f$   
4 - 7 GHz:  $\leq 1.21$

Material and plating descriptions may refer to the connector housing or outer contact.

SUCO\* = SUCOPLATE®  
SUPR\*\* = SUCOPRO

**113** H+S type  
Item no. **33\_SMB-SMA-50-1/111\_UE**  
22641727

**SMB SMA** plug (m)  
jack (f)

Packaging: single

Material:  
SMB: brass/gold  
SMA: CuBe/gold

VSWR: DC - 4 GHz:  $\leq 1.05 + 0.04f$

**117** H+S type  
Item no. **33\_TNC-SMA-50-1/1\_UE**  
22640940

**TNC SMA** plug (m)  
jack (f)

Packaging: single

Material:  
TNC: brass/SUCO\*  
SMA: CuBe/gold

VSWR: DC - 2 GHz:  $\leq 1.05$ ; 2 - 4 GHz:  $\leq 1.10$   
4 - 8 GHz:  $\leq 1.20$ ; 8 - 10 GHz:  $\leq 1.30$

**114** H+S type  
Item no. **31\_SMA-TNC-50-1/1\_UE**  
22640941

**SMA TNC** jack (f)  
jack (f)

Packaging: single

Material:  
SMA: CuBe/gold  
TNC: brass/SUCO\*

VSWR: DC - 1 GHz:  $\leq 1.05$ ; 1 - 2 GHz:  $\leq 1.10$   
2 - 6 GHz:  $\leq 1.20$ ; 6 - 10 GHz:  $\leq 1.30$

**118** H+S type  
Item no. **33\_SMB-TNC-50-2/1\_UE**  
22640400

**SMB TNC** plug (m)  
jack (f)

Packaging: single

Material:  
SMB: brass/gold  
TNC: brass/SUCO\*

VSWR: DC - 4 GHz:  $\leq 1.1 + 0.065f$

**115** H+S type  
Item no. **32\_SMA-TNC-50-1/1\_UE**  
22640938

**SMA TNC** plug (m)  
plug (m)

Packaging: single

Material:  
SMA: CuBe/gold  
TNC: brass/SUCO\*

VSWR: DC - 2 GHz:  $\leq 1.05$ ; 2 - 4 GHz:  $\leq 1.10$   
4 - 8 GHz:  $\leq 1.20$ ; 8 - 11 GHz:  $\leq 1.30$

**116** H+S type  
Item no. **33\_SMA-TNC-50-1/1\_NE**  
22640939

**SMA TNC** plug (m)  
jack (f)

Packaging: single

Material:  
SMA: CuBe/gold  
TNC: brass/SUCO\*

VSWR: DC - 6 GHz:  $\leq 1.03 + 0.05f$   
6 - 11 GHz:  $\leq 1.33$